

GS-76 End Mill Resharpener

I. Choose of Grinding Wheel & Accessories & Collet

1. Please unplug the power cord before changing grinding wheel.
2. Choose the proper grinding wheel according to the material of end mill.
 - Carbide / Tungsten material end mill use SD grinding wheel (Standard).
 - HSS material end mill use CBN grinding wheel (Optional).
3. For grinding Shelf (I) and Shelf (II), there are five different sizes of grinding wheel.
Choose the proper grinding wheel according to end mill's cutting diameter
 - Grinding Wheel A is for grinding the diameter from $\Phi 3.0\text{ mm} - \Phi 5.0\text{ mm}$.
 - Grinding Wheel B is for grinding the diameter from $\Phi 5.1\text{ mm} - \Phi 8.0\text{ mm}$.
 - Grinding Wheel C is for grinding the diameter from $\Phi 8.1\text{ mm} - \Phi 12.0\text{ mm}$.
 - Grinding Wheel D is for grinding the diameter from $\Phi 12.1\text{ mm} - \Phi 16.0\text{ mm}$.
 - Grinding Wheel E is for grinding the diameter from $\Phi 16.1\text{ mm} - \Phi 20.0\text{ mm}$.
4. Choose the proper bushing and chuck set according to the number of flute.
5. Choose the proper collet according to end mill's diameter.

II. Chuck Set Assembly Steps

1. Make sure there are no dust or scraps inside the clamping nut, collet and collet holder.
2. Put the collet into collet holder by 45° angle. (Fig. 2-1)
3. Screw in a little bit by clamping nut, then insert end mill shank into the clamping nut until the end mill tip is about 5 mm out of the clamping nut (Fig. 2-2), slightly screw the chuck set to tighten the end mill a little bit.
 - ※ Do not fully tighten the chuck set, make sure end mill can still be adjusted.
4. Turn the longer cutting edge of end mill to be parallel to the Slot No.1 of the clamping nut.(Fig. 2-3)

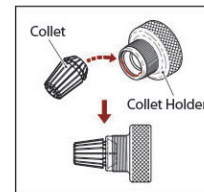

Fig. 2-1

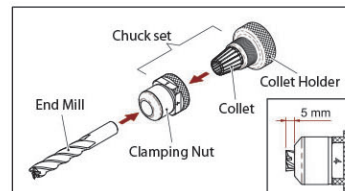

Fig. 2-2

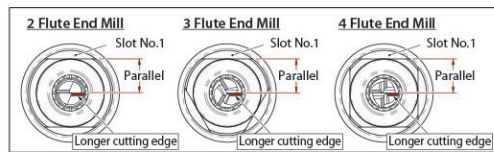

Fig. 2-3

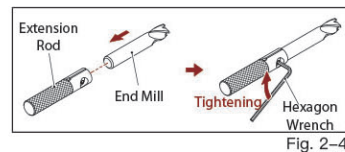

Fig. 2-4

- ※ If the end mill is too short, the extension rod in the accessory is available for use.

Choose the proper extension rod according to the end mill's shank diameter. Insert end mill's shank into the extension rod, and use 2 mm hexagon wrench to tighten the side screw of the extension rod to secure the end mill. (Fig. 2-4)

- ※ When assembling with the chuck set, put it in from the rear of the chuck set. (Fig. 2-5)

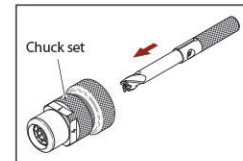

Fig. 2-5

III. The use of the Positioning Shelf

1. Preset the position of the alignment block. (Fig. 3-1)
 - ① Loosen the set screw by counterclockwise.
 - ② Pull out the alignment block to the end.
2. End mill positioning (Fig. 3-2) :
 - ① Align Slot No.1 of the clamping nut to the pin on the positioning shelf, insert the chuck set into the positioning shelf and fit them with no gaps, then turn the chuck set clockwise until it stops by the pin.
 - ② Slowly move the alignment block inward.
 - ③ Push the end mill to the end and slowly turn it clockwise until the outer corner of the end mill's longer cutting edge touches the tip of the alignment block.
 - ④ Turn the set screw clockwise to lock the alignment block.
 - ⑤ Tighten the chuck set to secure the end mill.
3. Gently turn the chuck set counterclockwise and take it out, make sure the end mill's longer cutting edge is parallel to the Slot No.1 of clamping nut (See Fig. 3-3).

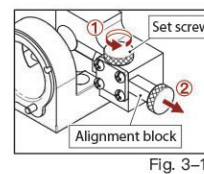

Fig. 3-1

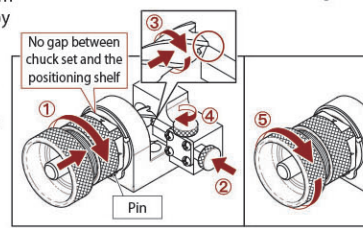

Fig. 3-2

- ※ If the end mill's longer cutting edge is angled away from the Slot No.1 of clamping nut (Fig. 3-3), change to the alignment block with a notch on the front, insert with the notch facing up (Fig. 3-4), then reposition the end mill.

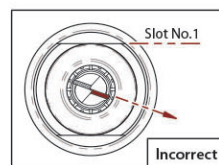

Fig. 3-3

- ※ Make sure the positioning result is correct before starting the grinding procedure.

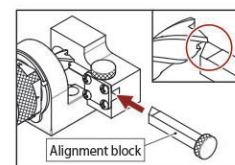
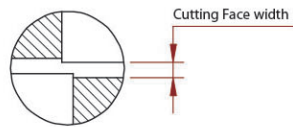

Fig. 3-4

IV. The use of the Cutting Face Adjustment Device

This device is to adjust the width of the cutting face. (Fig. 4-1)



1. Please turn it to "-" direction to the end then set to "0".
2. Turn to "+" direction to decrease the cutting face width.
Turn to "-" direction to increase the cutting face width.

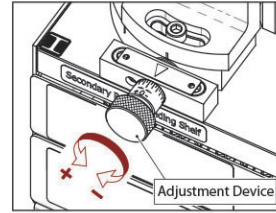

Fig. 4-1

V. 2 Flute End Mill Grinding Preparations

1. Secondary Relief Grinding Shelf (I) (Fig. 5-1)

- ① Move the adjustable pin on the Shelf (I) from the bottom to top.
- ② Adjust the cutting face adjustment device to "0", after finishing the whole sharpening procedure, then adjust this device according to your needs.

(See chapter "IV. The use of the Cutting Face Adjustment Device")

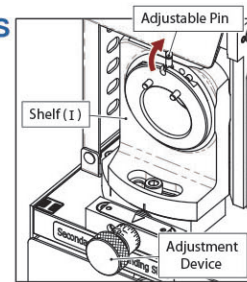

Fig. 5-1

2. Cutting Face Grinding Shelf (III) (Fig. 5-2)

- ① Adjust the Shelf (III) to 3°.
 - ② Insert 2 Flute Cutting Face Bushing into the Shelf (III), align No.1 of the bushing to the pin on the shelf, then insert it to the end.
- ※ The ● green mark of the bushing should align to the ● green mark on the shelf when inserting the bushing.

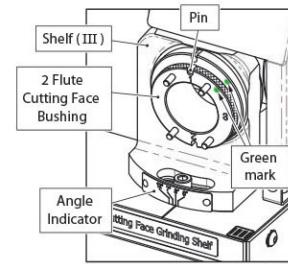

Fig. 5-2

VI. 2 Flute End Mill Grinding Process

Grinding procedure: I, III, IIII

Turn the power switch on and wait about 10 seconds until the motor rotation is stable.

- ※ Do not hold the end mill shank while grinding, it may affect the grinding accuracy.

1. 2 Flute Secondary Relief Grinding (I) (Fig. 6-1)

Insert the chuck set into the Shelf (I), align Slot No.1 of clamping nut to the two pins on the shelf, push the chuck set gently and turn it clockwise and counterclockwise until the grinding noise stops.
Turn the chuck set to grind the Slot No.2 in the same way.

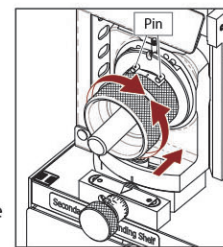

Fig. 6-1

2. 2 Flute Cutting Face Grinding (III) (Fig. 6-2)

- ① Insert the chuck set into the bushing on the Shelf (III), align Slot No.1 to the two pins where marked as No.1, push the chuck set gently until the grinding noise stops.
- ② Take the chuck set out and turn the bushing to No.2, align No.2 to the pin on the shelf, then insert it to the end.
- ③ Insert the chuck set into the bushing, align Slot No.2 to the two pins where marked as No.2, push the chuck set gently until the grinding noise stops.

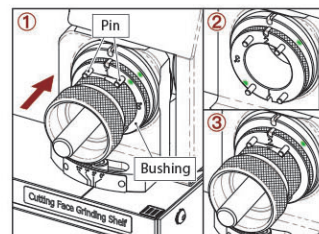

Fig. 6-2

3. 2 Flute End Gash Grinding (IIII) (Fig. 6-3)

Insert the chuck set into the Shelf (IIII), align Slot No.1 to the two pins on the shelf, push the chuck set gently until the grinding noise stops.
Turn the chuck set to grind the Slot No.2 in the same way.

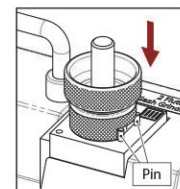

Fig. 6-3

VII. 3 Flute End Mill Grinding Preparations

1. Secondary Relief Grinding Shelf (I) (Fig. 7-1)

- ① Move the adjustable pin on the Shelf (I) from the bottom to top.
- ② Adjust the cutting face adjustment device to "0", after finishing the whole sharpening procedure, then adjust this device according to your needs.
(See chapter "IV. The use of the Cutting Face Adjustment Device")

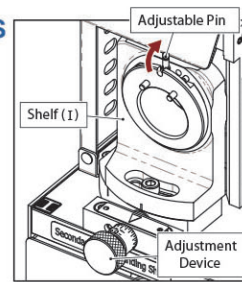

Fig. 7-1

2. End Gash Grinding Shelf (II) (Fig. 7-2) Insert 3 & 4 Flute End Gash Bushing into the Shelf (II), align No.(I · II) of the bushing to the pin on the shelf, then insert it to the end.

- ✳ The ● pink mark of the bushing should align to the ● pink mark on the shelf when inserting the bushing.

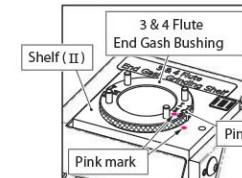

Fig. 7-2

3. Cutting Face Grinding Shelf (III) (Fig. 7-3)

- ① Adjust the Shelf (III) to 3°.
 - ② Insert 3 Flute Cutting Face Bushing into the Shelf (III), align No.1 of the bushing to the pin on the shelf, then insert it to the end.
- ✳ The ● green mark of the bushing should align to the ● green mark on the shelf when inserting the bushing.

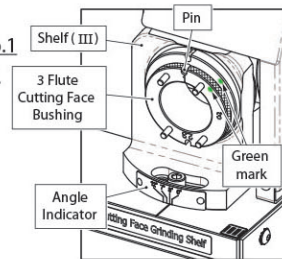

Fig. 7-3

VIII. 3 Flute End Mill Grinding Process

Grinding procedure: I, II, III

Turn the power switch on and wait about 10 seconds until the motor rotation is stable.

- ✳ Do not hold the end mill shank while grinding, it may affect the grinding accuracy.

1. 3 Flute Secondary Relief Grinding (I) (Fig. 8-1)

Insert the chuck set into the Shelf (I), align Slot No.1 of clamping nut to the two pins on the shelf, push the chuck set gently and turn it clockwise and counterclockwise until the grinding noise stops. Turn the chuck set to grind the Slot No.2 and Slot No.3 in the same way.

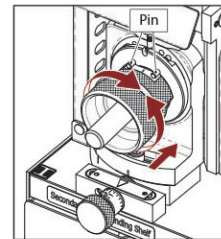

Fig. 8-1

2. 3 Flute End Gash Grinding (II) (Fig. 8-2)

- ① Insert the chuck set into the bushing on the Shelf (II), align Slot No.1 to the two pins where marked as No.(I · II), push the chuck set gently until the grinding noise stops. Turn the chuck set to grind the Slot No.2 in the same way.
- ② Take the chuck set out, turn the bushing to No.(III), align No.(III) to the pin on the shelf, then insert it to the end.
- ③ Insert the chuck set into the bushing, align Slot No.3 to the two pins where marked as No.(III), push the chuck set gently until the grinding noise stops.

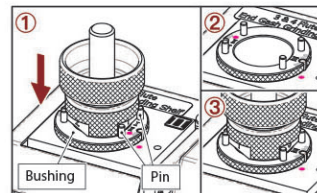

Fig. 8-2

3. 3 Flute Cutting Face Grinding (III) (Fig. 8-3)

- ① Insert the chuck set into the bushing on the Shelf (III), align Slot No.1 to the two pins where marked as No.1, push the chuck set gently until the grinding noise stops.
- ② Take the chuck set out, turn the bushing to No.(2 · 3), align No.(2 · 3) to the pin on the shelf, then insert it to the end.
- ③ Insert the chuck set into the bushing, align Slot No.2 to the two pins where marked as No.(2 · 3), push the chuck set gently until the grinding noise stops. Turn the chuck set to grind the Slot No.3 in the same way.

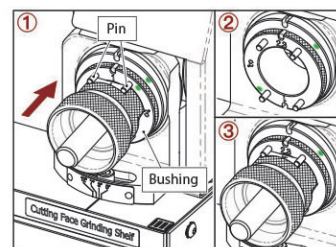

Fig. 8-3

IX. 4 Flute End Mill Grinding Preparations

1. Secondary Relief Grinding Shelf (I) (Fig. 9-1)

- ① Move the adjustable pin on the Shelf (I) from the top to bottom.
- ② Adjust the cutting face adjustment device to "0", after finishing the whole sharpening procedure, then adjust this device according to your needs.
(See chapter "IV. The use of the Cutting Face Adjustment Device")

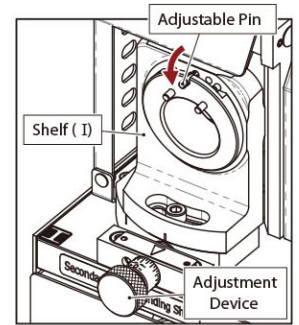

Fig. 9-1

2. End Gash Grinding Shelf (II) (Fig. 9-2)

Insert 3 & 4 Flute End Gash Bushing into the Shelf (II), align No.(1 · 3) of the bushing to the pin on the shelf, then insert it to the end.

- ✘ The ● pink mark of the bushing should align to the ● pink mark on the shelf when inserting the bushing.

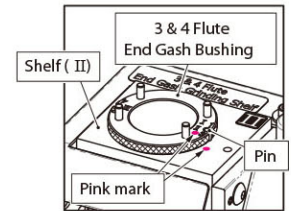

Fig. 9-2

3. Cutting Face Grinding Shelf (III) (Fig. 9-3)

- For grinding the diameter from $\varnothing 3.0 - 8.0$ mm.

- ① Adjust the Shelf (III) to 12°.
- ② Choose 4 Flute Cutting Face Bushing (12 deg).

- For grinding the diameter from $\varnothing 8.1 - 12.0$ mm.

- ① Adjust the Shelf (III) to 7°.
- ② Choose 4 Flute Cutting Face Bushing (7 deg).

- For grinding the diameter from $\varnothing 12.1 - 20.0$ mm.

- ① Adjust the Shelf (III) to 3°.
- ② Choose 4 Flute Cutting Face Bushing (3 deg).

Insert the proper bushing into the Shelf (III), align No.1 of the bushing to the pin on the shelf, then insert it to the end.

- ✘ The ● green mark of the bushing should align to the ● green mark on the shelf when inserting the bushing.

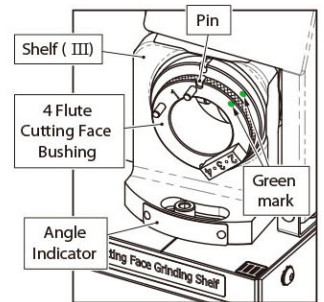

Fig. 9-3

X. 4 Flute End Mill Grinding Process

Grinding procedure: I, II, III

Turn the power switch on and wait about 10 seconds until the motor rotation is stable.

- ✘ Do not hold the end mill shank while grinding, it may affect the grinding accuracy.

1. 4 Flute Secondary Relief Grinding (I) (Fig. 10-1)

Insert the chuck set into the Shelf (I), align Slot No.1 of clamping nut to the two pins on the shelf, push the chuck set gently until the grinding noise stops.

Turn the chuck set to grind the Slot No.2, Slot No.3 and Slot No.4 in the same way.

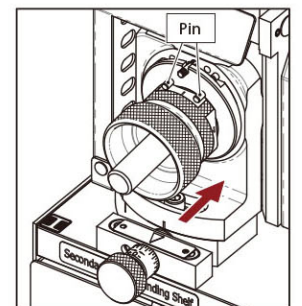

Fig. 10-1

2. 4 Flute End Gash Grinding (II) (Fig. 10-2)

- ① Insert the chuck set into the bushing on the Shelf (II), align Slot No.1 to the two pins where marked as No.(1 · 3), push the chuck set gently until the grinding noise stops. Turn the chuck set to grind the Slot No.3 in the same way, then take the chuck set out.
- ② Turn the bushing to No.(2 · 4), align No.(2 · 4) to the pin on the shelf, then insert it to the end.
- ③ Insert the chuck set into the bushing, align Slot No.2 to the two pins where marked as No.(2 · 4), push the chuck set gently until the grinding noise stops. Turn the chuck set to grind the Slot No.4 in the same way.

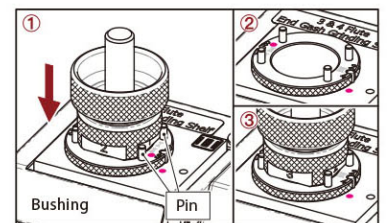

Fig. 10-2

3. 4 Flute Cutting Face Grinding (III) (Fig. 10-3)

- ① Insert the chuck set into the bushing on the Shelf (III), align Slot No.1 to the two pins where marked as No.1, push the chuck set gently until the grinding noise stops, then take the chuck set out.
- ② Turn the bushing to No.(2 · 3 · 4), align No.(2 · 3 · 4) to the pin on the shelf, then insert it to the end.
- ③ Insert the chuck set into the bushing, align Slot No.2 to the flat key where marked as No.(2 · 3 · 4), push the chuck set gently until the grinding noise stops. Turn the chuck set to grind the Slot No.3 and Slot No.4 in the same way.

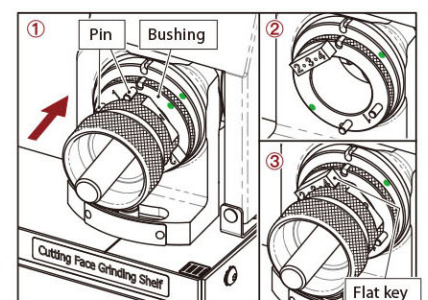

Fig. 10-3